

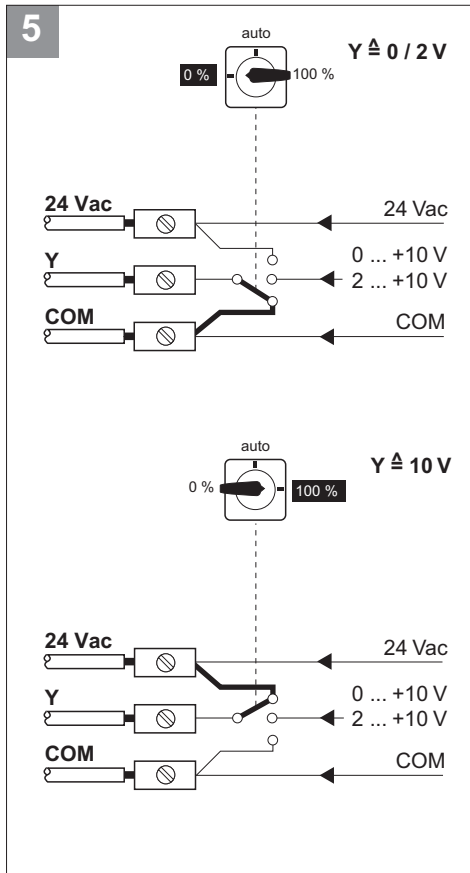

M7410E

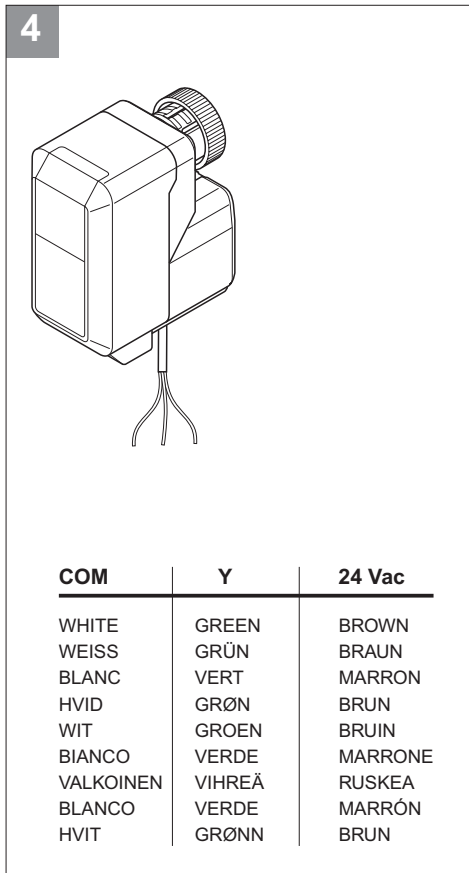

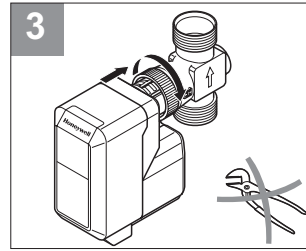
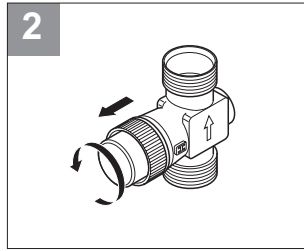
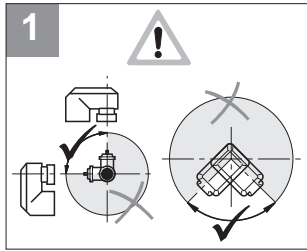
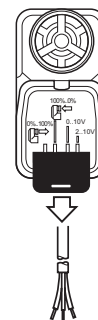
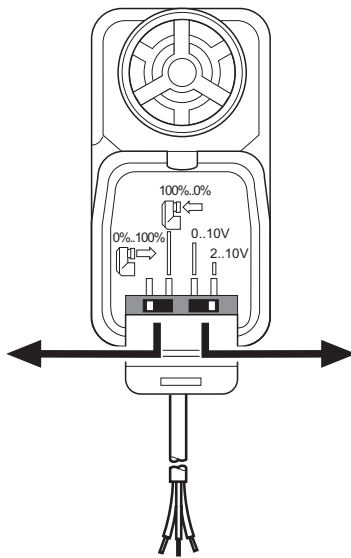
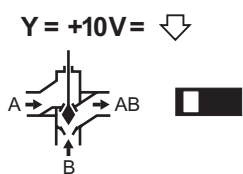
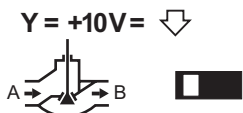
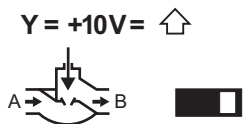

 **Y = 0...+10V**

 **Y = 2...+10V**